

**NEW**

# INNOTOOL

LOOK FORWARD

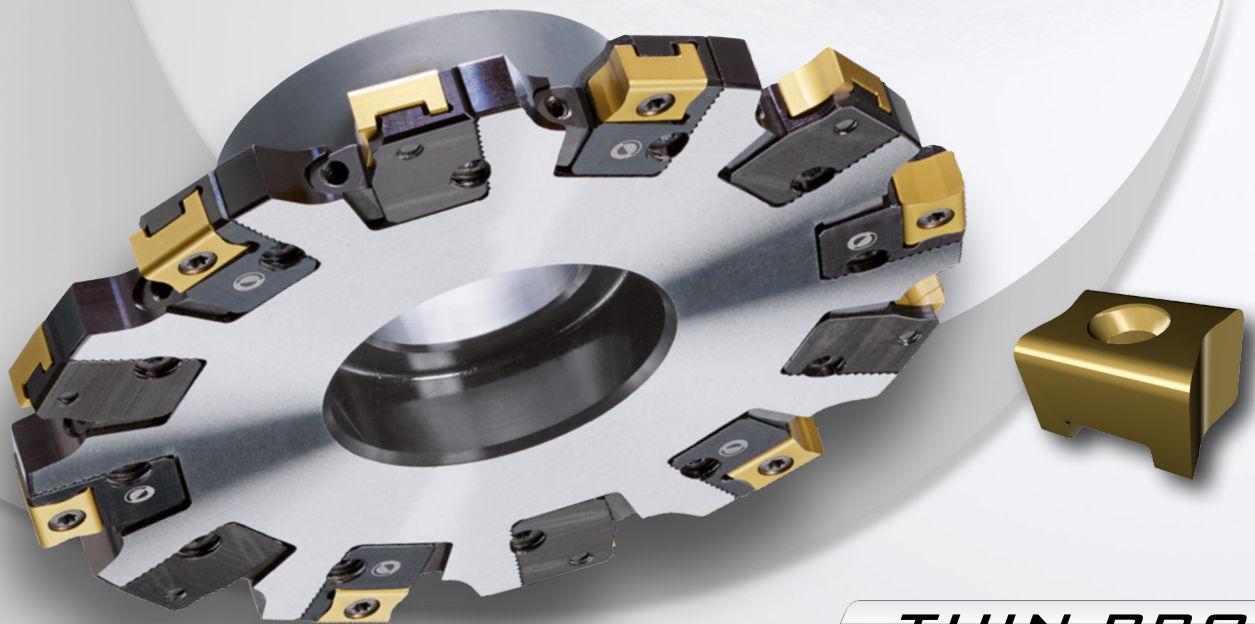

**THIN PRO**

## ADJUSTABLE SIDE AND FACE CUTTERS DID10

*For flat slot bases in cutting width range of 11 - 17 mm •*

*Sturdy design •*

*High chip removal capacity •*

*High process reliability •*

*High axial runout accuracy •*

## Product Overview

The adjustable side and face cutters presented here supplement the **ThinPro** side and face cutter series with fixed insert pockets in the diameter range **100 - 315 mm**, which have already been successfully placed in the market. The new cutting width range is **11 - 17 mm** and thus follows the existing series with 3 - 10 mm cutting widths.

The so-called bridge-style insert, developed especially for this series of milling cutters, got its name from the pressed recess, which provides enough depth of engagement for the screw thread, even for narrow widths of cut, as shown in the following illustration.

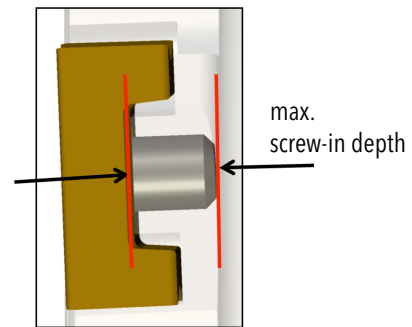

## Application Range

In addition to the known advantages of the tangential design (stability, high chip removal capacity, high process reliability), this new tool series also makes it possible to generate a flat slot base, without V-shape. This is made possible by a special grinding angle on the insert, which compensates the angular error that is caused by the lateral release of the insert in the main body.

The corner radii in the standard range are **R0.4 / R0.8 / R1.6 and R3.2 mm**, depending on the respective insert type and the cutting width of the tool.

The cutting width range **11 - 17 mm** is covered by just 2 insert types.

The inserts **IXH415...** and **IXH416...** are mounted on axially adjustable holders, which make it possible to adjust the cutting width and also to serve as spare part in the event of a crash or if an insert breaks.

## Advantages

- High economic efficiency thanks to 4 cutting edges with double-positive geometry.
- Different corner radii are available.
- Large selection of carbide qualities for machining all kinds of materials.
- The same insert can be used in right and left insert pockets.
- Flat slot base.
- High process reliability thanks to the tangential mounting position of the cutting edge.
- Precise axial runout and cutting width adjustment.

This series offers an economic and competitive slot-milling concept in conjunction with inserts with the latest coating technology.



**Technical Features**



insert contact surfaces

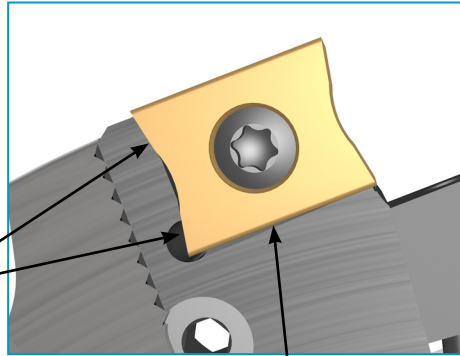

insert contact surface

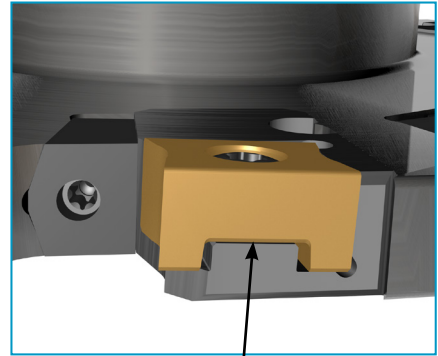

insert contact surfaces

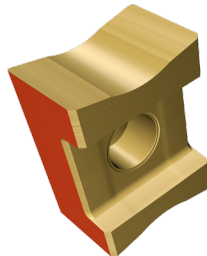

stable insert clamping with bridge-style design

positive insert design for a smooth cut

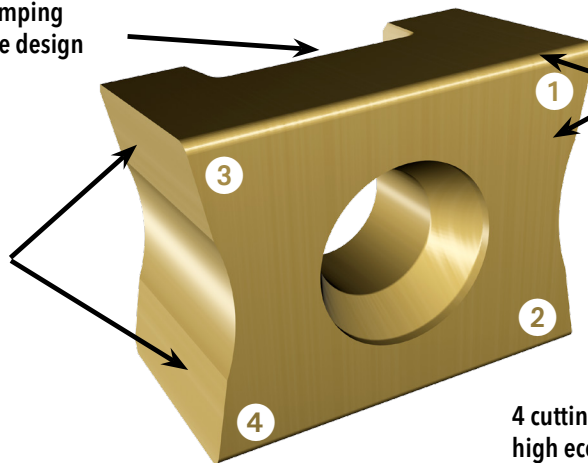

ground insert for precise machining results

4 cutting edges for high economic efficiency

ADAPTION ACC. TO DIN 8030

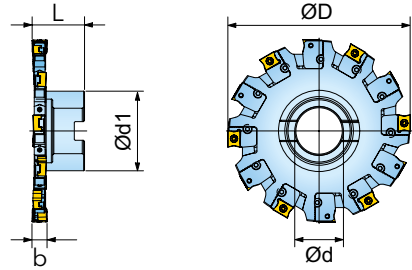
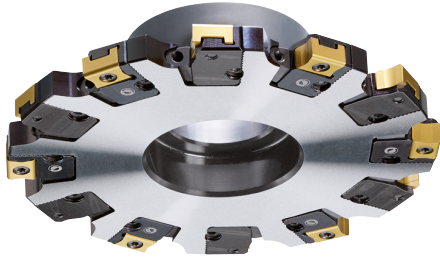

Designation	D	d	d1	L	b	Z	Zeff	kg
DI.100.017	100	27	47	45	11-13	6	3	0,87
DI.125.015	125	32	58	45	11-13	8	4	1,14
DI.160.015	160	40	70	45	11-13	12	6	1,76
DI.200.006	200	40	90	45	11-13	14	7	3,24
DI.250.001	250	60	130	45	11-13	18	9	5,31
DI.315.001	315	60	130	45	11-13	20	10	7,41

IXH415-G01	IXH415-G02	IXH415-G03
IXH415-G04	IXH415-G01-P	

Designation	fz(min/max)	Design	Grade	IN05S	IN4005	IN4030	IN4035				
IXH415-G01	0,08/0,25	positive geometry R0,4									
IXH415-G02	0,08/0,25	positive geometry R0,8									
IXH415-G03	0,08/0,25	positive geometry R1,6									
IXH415-G04	0,08/0,25	positive geometry R3,2									
IXH415-G01-P	0,05/0,20	positive geometry, polished R0,4									

● = P ● = M ● = K ● = N ● = S ○ = H

SPARE PARTS

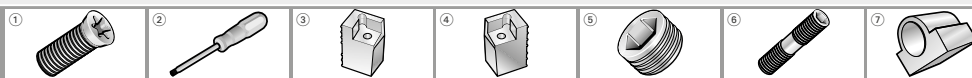

SM40-090-00 (4,5Nm) DST15S      4W101R00      4W101L00      SC080-01      SB040-07      2K0410-02

① = Insert screw   ② = Screw driver   ③ = Cartridge RH   ④ = Cartridge LH   ⑤ = Setting screw   ⑥ = Differential screw   ⑦ = Locking wedge

THIN PRO DID10 11-13 MM



ADAPTION ACC. TO DIN 8030

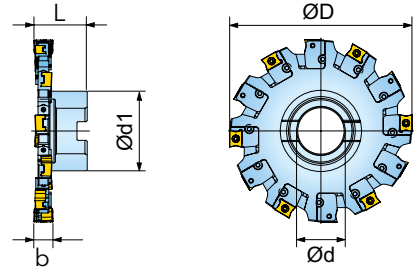
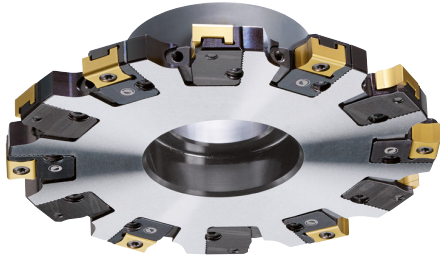

Designation	D	d	d1	L	b	Z	Zeff	kg
DI.100.018	100	27	47	45	13-17	6	3	0,94
DI.125.016	125	32	58	45	13-17	8	4	1,27
DI.160.016	160	40	70	45	13-17	12	6	1,97
DI.200.007	200	40	90	45	13-17	14	7	3,58
DI.250.002	250	60	130	45	13-17	18	9	5,80
DI.315.002	315	60	130	45	13-17	20	10	8,35

IXH416-G01	IXH416-G02	IXH416-G03
IXH416-G04	IXH416-G01-P	

Designation	fz(min/max)	Design	Grade	IN05S	IN4005	IN4030	IN4035				
IXH416-G01	0,08/0,25	positive geometry R0,4			●	●	●				
IXH416-G02	0,08/0,25	positive geometry R0,8			●	●	●				
IXH416-G03	0,08/0,25	positive geometry R1,6			●	●	●				
IXH416-G04	0,08/0,25	positive geometry R3,2			●	●	●				
IXH416-G01-P	0,05/0,20	positive geometry, polished R0,4	●								

● = P ● = M ● = K ● = N ● = S ○ = H

SPPARE PARTS	①	②	③	④	⑤	⑥	⑦
	SM40-110-00 (4,5Nm)	DS-T15S	4W121R00	4W121L00	SC080-01	SB040-07	2K0410-02

① = Insert screw ② = Screw driver ③ = Cartridge RH ④ = Cartridge LH ⑤ = Setting screw ⑥ = Differential screw ⑦ = Locking wedge

## Adjustment Instructions

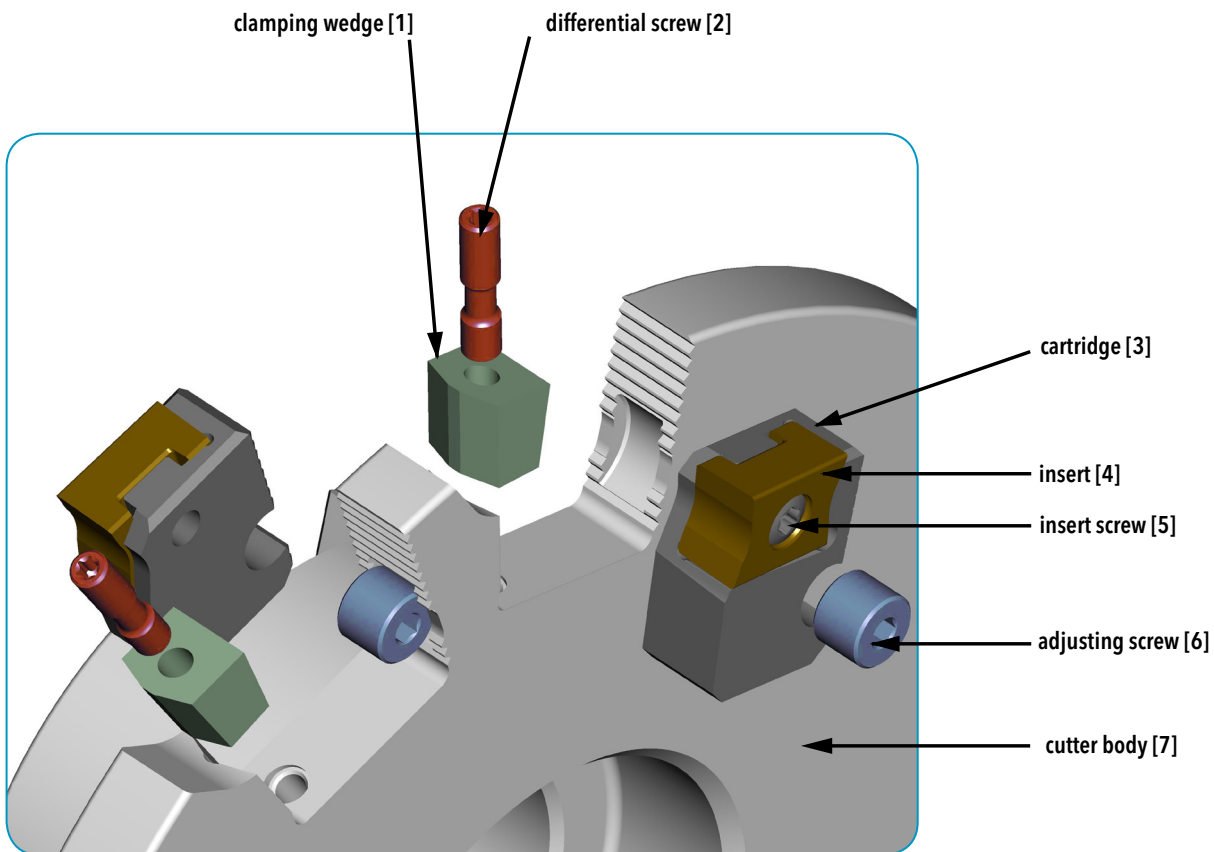

1. Mount adjusting screw [6] lightly greased into the cartridge [3].
2. Screw the lightly greased differential screw [2] into the mounting wedge [1] until it overlaps approx. 1 mm from the wedge surface.
3. Mount cartridge [3] into the cutter body [7], so that screw [6] is positioned in the circular groove at the cartridge contact face.
4. Fix the cartridge [3] with your fingers and use differential screw [2] to position the clamping wedge [1] in the V-shape of the cutter body [7] and mount it loosely free of clearance.
5. Repeat steps 1 - 4 for the opposite cartridge and proceed diagonally until all cutter slots are mounted with cartridges.
6. Tool height and cutting width are adjusted with the mounted insert [4] in the cartridge [3] with adjusting screw [6] on a measuring table and dialgauge according to the parameters and cutting width range in the catalogue. A runout inspection fixture or profile projector simplifies the adjustment.
7. After the exact cutting edge position has been reached, please tighten the differential screw [2] with a torque wrench adjusted 2.5 Nm.
8. Repeat steps 6 - 7 for all cartridges, until the exact cutting width is adjusted and an axial run-out of 0,02 - 0,03 mm has been reached.

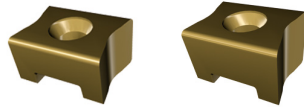
**Tips and Parameters**

insert:

**IXH415****IXH416**

average chip thickness:

**hm = 0.15 mm****hm = 0.15 mm****Recommended cutting data:**

material	cutting speed Vc [m/min]				average chip thickness hm [mm]
	1st choice dry machining resp. wear resistant carbide		1st choice wet machining resp. tough carbide		
unalloyed steel	IN4005	150 - 250	IN4030	120 - 200	hm x 1.2
alloyed steel 800 N/mm <sup>2</sup>	IN4005	120 - 180	IN4030	100 - 160	hm x 1.0
alloyed steel 1100 N/mm <sup>2</sup>	IN4005	100 - 180	IN4030	80 - 160	hm x 0.9
stainless steel	IN4035	80 - 160	IN4035	80 - 160	hm x 1.2
gray cast iron	IN4030	160 - 250	IN4030	140 - 200	hm x 1.2
nodular cast iron	IN4030	120 - 200	IN4030	100 - 180	hm x 1.0
aluminum	IN05S	500 - 1200	IN05S	400 - 800	hm x 1.3
high temperature alloys	IN4005	50 - 80	IN4030	40 - 70	hm x 0.9
titanium alloys	-	-	IN4005	30 - 40	hm x 1.0
hard machining < 54 HRC	-	-	-	-	-
hard machining < 63 HRC	-	-	-	-	-

**Tips:**

- The worse the material machinability, the smaller the tool engagement should be chosen.
- The smaller the cutting tool diameter, the higher the cutting speed can be.
- If tool engagement is less than 1/3 of cutting tool diameter, the feed per tooth should be calculated with the following formula:

$$fz = hm \times \sqrt{\frac{D}{ae}}$$

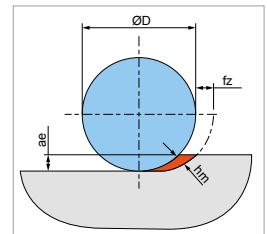
**General information:**insert screw size 415:  
torque wrench:**SM40-090-00**  
**DT-40-01 with bit DS-T15B**torque: **4.5 Nm**insert screw size 416:  
torque wrench:**SM40-110-00**  
**DT-40-01 with bit DS-T15B**torque: **4.5 Nm**

Successful machining results depend on many factors, so cutting data recommendations can only be a rough guideline. Therefore in any case of doubt do not hesitate to contact your Innotool partner.

# INNOTOOL

## INNOVATIVE CUTTING TOOLS

Florianstraße 13-17

71665 Vaihingen-Horrheim, Germany

Tel.: +49 (0)7042-8316-0

Fax: +49 (0)7042-8316-26

E-Mail: [info@innotool.de](mailto:info@innotool.de)

[www.innotool.de](http://www.innotool.de)

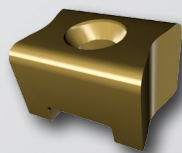

**THIN PRO**